

# TC-H500

## SERVICE MANUAL

*US Model  
Canadian Model  
AEP Model  
UK Model*

This set is the cassette deck section in MHC-2500, MHC-3500, MHC-5500.





### SPECIFICATIONS

Recording system	4-track 2-channel stereo
Frequency response	(DOLBY NR OFF) 40 - 13,000 Hz ( $\pm 3$ dB), using TYPE I cassette (Sony HF-S) 40 - 14,000 Hz ( $\pm 3$ dB), using TYPE II cassette 40 - 15,000 Hz ( $\pm 3$ dB), using TYPE IV cassette
Wow and flutter	0.1% WRMS $\pm 0.3\%$ (DIN)
Dimensions	Approx. 225 x 118 x 235 mm (w/h/d) (9 x 4 $\frac{3}{4}$ x 9 $\frac{3}{8}$ inches)
Weight	Approx. 2.5 kg (5 lb 8 oz)

Design and specifications subject to change without notice.

Model Name Using Similar Mechanism	TC-818M
Tape Transport Mechanism Type	Deck A TCM-170RA1
	Deck B TCM-170RB7

### SAFETY-RELATED COMPONENT WARNING!!

COMPONENTS IDENTIFIED BY MARK  OR DOTTED LINE WITH MARK  ON THE SCHEMATIC DIAGRAMS AND IN THE PARTS LIST ARE CRITICAL TO SAFE OPERATION. REPLACE THESE COMPONENTS WITH SONY PARTS WHOSE PART NUMBERS APPEAR AS SHOWN IN THIS MANUAL OR IN SUPPLEMENTS PUBLISHED BY SONY.

### ATTENTION AU COMPOSANT AYANT RAPPORT À LA SÉCURITÉ!

LES COMPOSANTS IDENTIFIÉS PAR UNE MARQUE  SUR LES DIAGRAMMES SCHÉMATIQUES ET LA LISTE DES PIÈCES SONT CRITIQUES POUR LA SÉCURITÉ DE FONCTIONNEMENT. NE REMPLACER CES COMPOSANTS QUE PAR DES PIÈCES SONY DONT LES NUMÉROS SONT DONNÉS DANS CE MANUEL OU DANS LES SUPPLÉMENTS PUBLIÉS PAR SONY.

Dolby noise reduction manufactured under license from Dolby Laboratories Licensing Corporation. "DOLBY" and the double-D symbol  are trademarks of Dolby Laboratories Licensing Corporation.

# STEREO CASSETTE DECK SONY®

**REPAIRING PRECAUTION**

**[To apply B+ voltage]**

The power of this unit is fed from amplifier. Because of this, connect the DC Power supply as illustrated below when this unit alone operates.

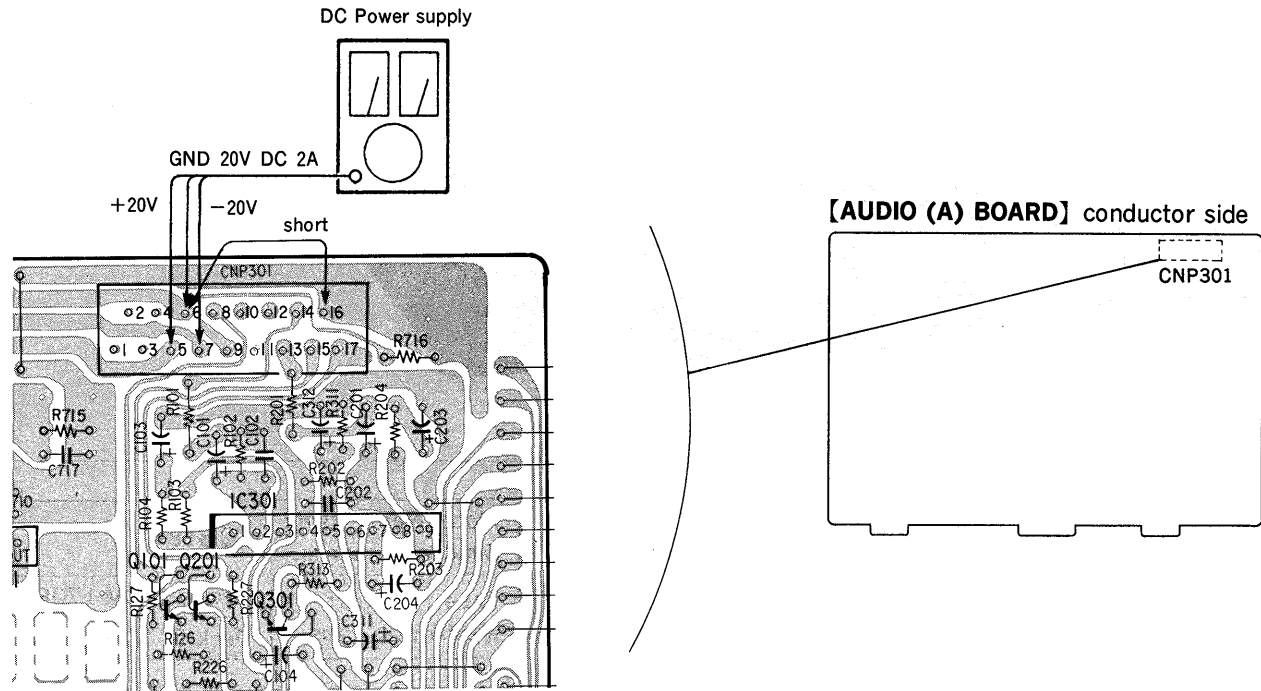

**SECTION 1  
GENERAL**

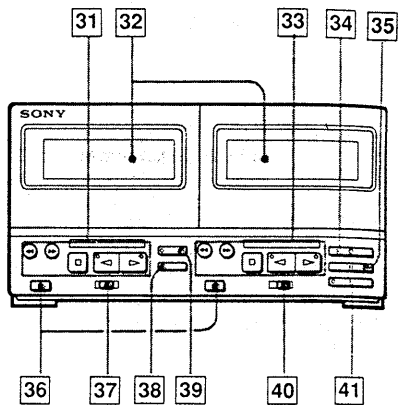

- 31 Tape operation buttons for deck A  
 ◀▶: Fast winding  
 □: Stop  
 △: Reverse play  
 ▽: Forward play
- 32 Cassette holders
- 33 Tape operation buttons for deck B
- 34 REC (recording) button
- 35 PAUSE button
- 36 EJECT buttons
- 37 DIRECTION MODE selector
- 38 TAPE DUBBING HIGH SPEED button
- 39 CD SYNCHRO (CD synchronized recording) button
- 40 DOLBY NR selector
- 41 AMS (Automatic Music Sensor)/BLANK SKIP button

## SECTION 2 ADJUSTMENTS

### 2-1. MECHANICAL ADJUSTMENTS

#### PRECAUTION

1. Clean the following parts with a denatured-alcohol-moistened swab :
 

record/playback head	pinch roller
erase head	rubber belts
capstan	idler
2. Demagnetize the record/playback head with a head demagnetizer.
3. Do not use a magnetized screwdriver for the adjustments.
4. After the adjustments, apply suitable locking compound to the parts adjusted.

#### Torque Measurement

Torque	Torque Meter	Meter Reading
FWD	CQ-102C	30 to 60g·cm (0.416 to 0.833 oz·inch)
FWD Back tension	CQ-102C	1 to 5g·cm (0.014 to 0.069 oz·inch)
REV	CQ-102RC	30 to 60g·cm (0.416 to 0.833 oz·inch)
REV Back Tension	CQ-102RC	1 to 5g·cm (0.014 to 0.069 oz·inch)
FF, REW	CQ-201B	100 to 170g·cm (1.39 to 2.36 oz·inch)

#### • Location of LINE IN/OUT

#### AUDIO Board (A) CNP301

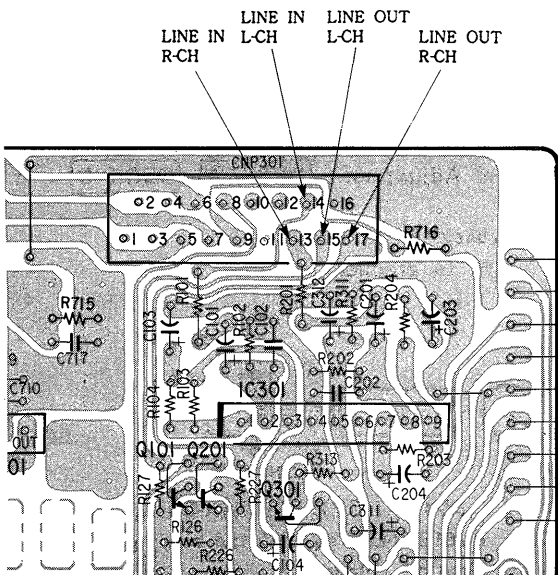

### 2-2. ELECTRICAL ADJUSTMENTS

**Note :**The adjustment should be performed in the order given in the service manual.

The adjustments should be performed for both L-CH and R-CH.

- Switches and controls should be set as follows unless otherwise specified.

DOLBY NR switch : OFF

- Standard Record :

Deliver the standard input signal level to the input jack and set the REC LEVEL control to obtain the standard output signal level.

—Record Mode—

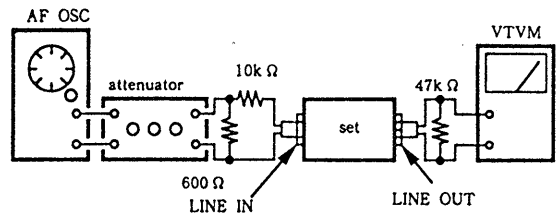

#### Standard Input Level

INPUT terminal	LINE IN
source impedance	10kΩ
input level	0.31V (-8dB)

#### Standard Output Level

OUTPUT terminal	LINE OUT
load impedance	47kΩ
output level	0.25V (-10dB)

#### • Test tape

Type	Signal	Used for
P-4-A100	10kHz, -10dB	Azimuth Adjustment
P-4-L300	315Hz, 0dB	PB LEVEL Adjustment
WS-48B	3kHz, 0dB	Tape Speed Adjustment

#### Record/Playback Head Azimuth Adjustment

DECK A    DECK B

#### Procedure :

1. Mode : FWD playback

test tape  
P-4-A100  
(10kHz, -10dB)

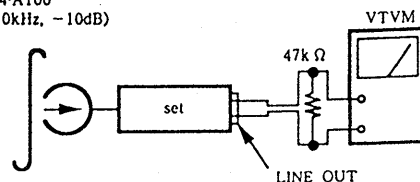

- Turn the adjustment screw for the maximum output levels. If these levels do not match, turn the adjustment screw until both of output levels match together within 1dB.

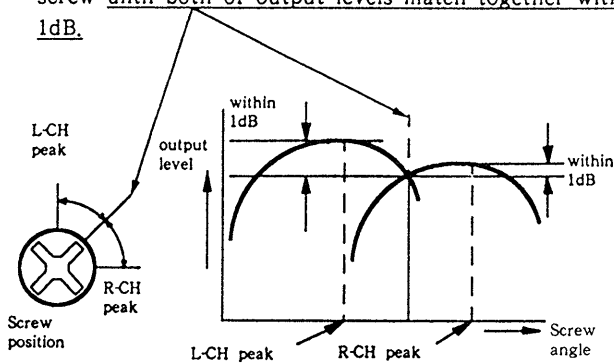

- Phase Check  
Mode : playback

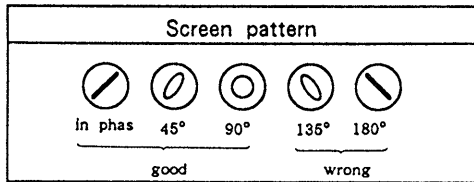
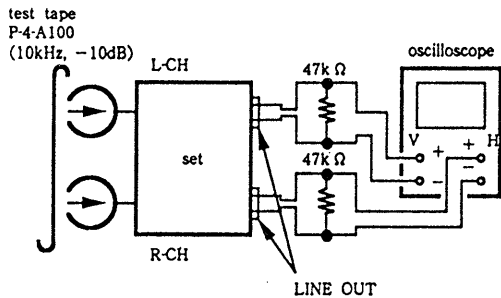

- Set in the REV mode and repeat the step 1-3.
- After the adjustment, lock the screws with locking compound.

Adjustment Location : Record/Playback head  
(Adjustable without disassembly.)

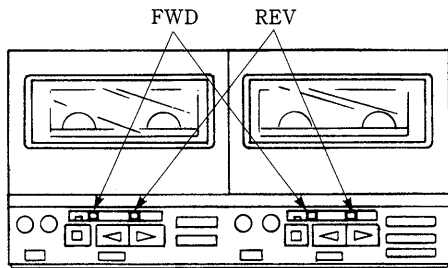
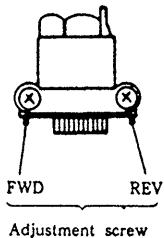

**Tape Speed Adjustment** DECK A DECK B

Procedure :  
Mode : FWD playback

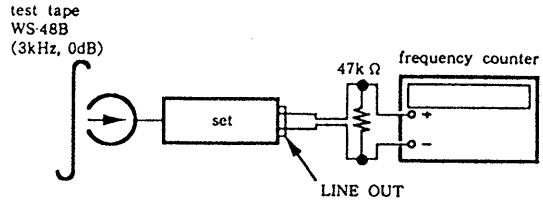

Perform high speed adjustment before normal speed adjustment.  
Connect TP1 to ground with jumper wire and continue to press HIGH SPEED DUBING switch : High speed playback. After the high speed adjustment, remove jumper wire of TP1.  
Play back the test tape WS-48B and adjust to meet the specifications below.

speed	deck	Adjustment Part	variable resistor of motor	S805 High speed dubbing	frequency counter reading
high	A	M11A	(H)	ON	5,960±20Hz
	B	M11B	(H)		
normal	A	M11A	(L)	OFF	2,980±10Hz
	B	M11B	(L)		

Frequency difference between the beginning and the end of the tape should be within 3%.  
Frequency difference between deck A and deck B the beginning of the tape should be within 1.5%.

**Adjustment Location :**

- deck A : motor (M11A) rear side
- deck B : motor (M11B) rear side

**Playback Level Adjustment** DECK A DECK B

Procedure :  
Mode : playback  
Connect TP1 to ground.

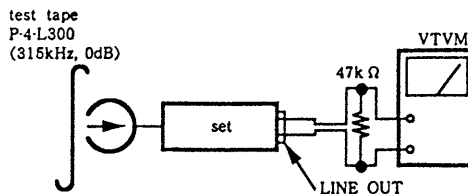

Adjust deck A : RV41A(L-CH), RV61A(R-CH) and deck B : RV41B(L-CH) , RV61B(R-CH) so that the reading on VTVM meets the specification below.

LINE OUT level :  $-10 \pm 0.5\text{dB}$  (0.23 to 0.26V)

Level difference between channels : less than 0.5dB

Check that the LINE OUT level does not change in playback mode while changing the mode from playback to stop several times.

Adjustment Location : MD board

**Record Bias Adjustment** DECK B

**Setting :**

REC LEVEL control : standard record (See page 3.)  
Connect TP1 to ground.

**Procedure :**

1. Mode : record

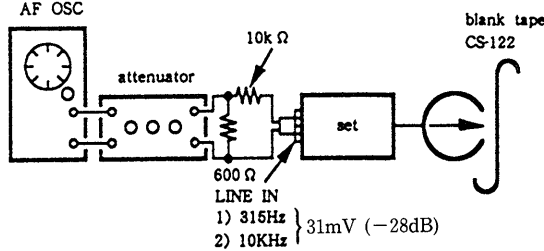

2. Mode : playback

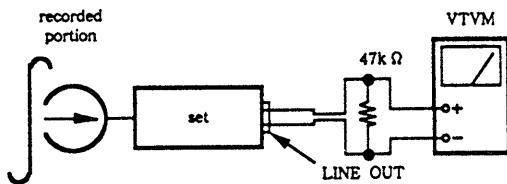

Confirm that the 10kHz playback output is  $0 \pm 0.5\text{dB}$  relative to the 315Hz output. If necessary, adjust RV42 (L-CH), RV62 (R-CH) and repeat the steps given above. After the adjustment remove jumper wire of TP1.

**Adjustment Location :** MD B board

**Record Level Adjustment** DECK B

**Setting :**

REC LEVEL control : standard record (See page 3.)  
Connect TP1 to ground.

**Procedure :**

1. Mode : record

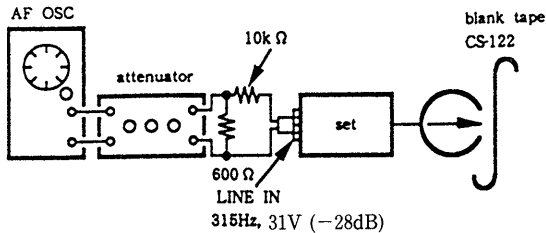

2. Mode : playback

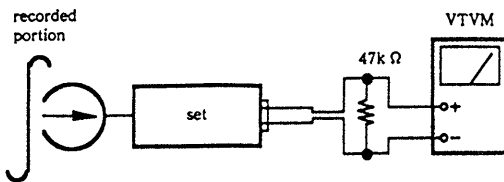

3. Play back the signal recorded in step 1.  
Confirm that the signal level is within the specification below. If necessary, adjust RV101 (L-CH), RV201 (R-CH) and repeat the step1-3.

4. After the adjustment, remove jumper wire of TP1.

LINE OUT level :  $-30 \pm 0.5\text{dB}$  (23 to 26nV)

**Adjustment Location :** audio (B) board

**-Adjusting Parts Location Diagram-**

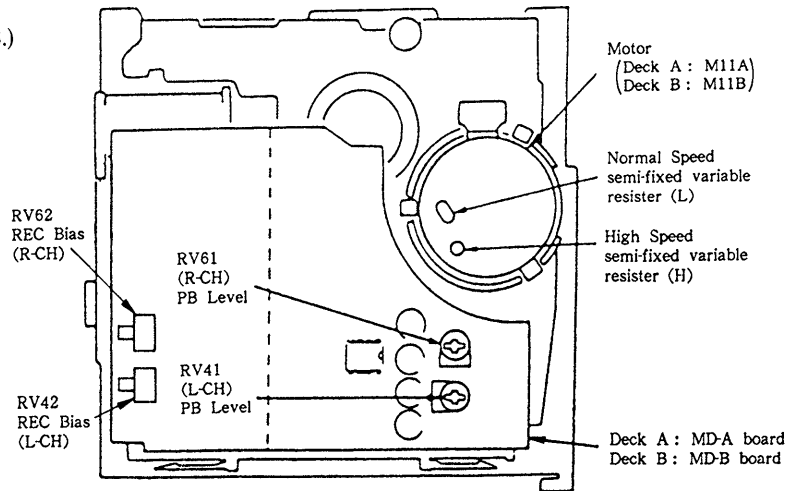

**AUDIO (B) BOARD**  
-Component Side-

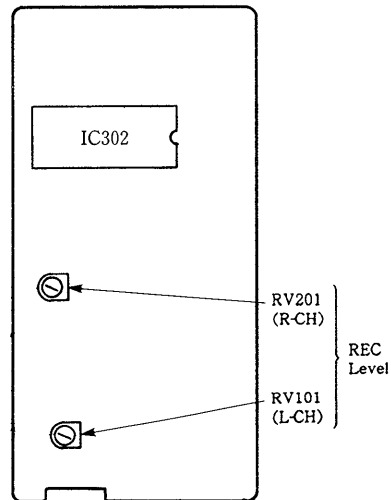

## SECTION 3 DIAGRAMS

### 3-1. IC801 M50964-223SP PIN FUNCTIONS

PIN No.	PIN NAME	I/O	SIGNAL NAME	FUNCTION											
1	Vcc		Vcc	POWER 5 ±0.5 V											
2	AVSS		AVSS	Analogue system GND											
3	VREF	I	VREF	Analogue system reference voltage input											
4	D-A	O	D-A	D/A conversion output (Not used : OPEN)											
5	PWM	O	PWM	PWM output (Not used : GND)											
6	P63	O	$\overline{\text{AMS}}$	AMS LED indication output											
7	P62	O	$\overline{\text{A FWD}}$	Deck A FWD LED output											
8	P61	O	$\overline{\text{BIAS IV}}$	TYPE IV bias oscillation output											
9	P60	O	$\overline{\text{BIAS II}}$	TYPE II bias oscillation output											
10	P47	O	$\overline{\text{A REV}}$	Deck A RVS LED output											
11	P46	O	$\overline{\text{A REV}}$	Deck A RVS LED output											
12	AN5	I	B HALF	Deck B Record prevention claw A, B detection input (Analogue)											
				Voltage (V)	1 V	1.9 V	2.8 V	3.9 V	5 V						
				Half	ON	ON	ON	ON	OFF						
				Claw A	OFF	ON	OFF	ON	OFF						
				Claw B	ON	ON	OFF	OFF	OFF						
13	AN4	I	KEY3	KEY input											
14	AN3	I	KEY2	Voltage (V)	0	0.3	0.7	1.2	1.7	2.3	2.8	3.4	4.0	4.5	5.0
				KEY1	B■	B	B▶	B◀	B○	A◀◀	A▶▶		□ B	□ C	OFF
15	AN2	I	KEY1	KEY2	A■	A	A▶	A◀		B◀◀	B▶▶	B●	↻	RELAY	OFF
				KEY3	AMS		HDUB	NDUB							
16	P41	O	$\overline{\text{B FWD}}$	Deck B FWD LED output											
17	P40	O	$\overline{\text{B REV}}$	Deck B RVS LED output											
18	P37	O	$\overline{\text{A FWD}}$	Deck A FWD LED output											
19	P36	O	$\overline{\text{B PAUSE}}$	Deck B PAUSE LED output											
20	P35	O	$\overline{\text{B REC}}$	Deck B REC LED output											
21	P34	O	DOLBY $\overline{\text{B/C}}$	Dolby $\overline{\text{B/C}}$ output											
22	P33	O	DOLBY $\overline{\text{ON/OFF}}$	Dolby $\overline{\text{ON/OFF}}$ output											
23	P32	I	SIRCS	SIRCS input or AUDIO BUS reverse input											
24	P31	O	$\overline{\text{70/120}}$	Playback EQ output for playing deck											
25	P30	O	AUB OUT	AUDIO BUS output											
26	INTI	I	AUB IN	AUDIO BUS normal input											
27	CNVSS		CNVSS	GND											
28	$\overline{\text{RESET}}$	I	$\overline{\text{RESET}}$	Microcomputer reset input											
29	XIN	I	XIN	Clock input (4 MHz)											
30	XO	O	XO	Clock output (4 MHz)											
31	$\Phi$	O	$\Phi$	(Not used : OPEN)											
32	Vss		Vss	GND											
33	P57	I	$\overline{\text{TEST}}$	Electrical adjusting test mode setting											
34	P56	I	TYPE IV	TYPE IV switch input											
35	P55	I	$\overline{\text{B70/120}}$	Deck B TYPE II switch input											
36	P54	I	B SHUT	Deck B Reel table signal input											
37	P53	I	$\overline{\text{A70/120}}$	Deck A TYPE II switch input											
38	P52	I	A SHUT	Deck B Reel table signal input											
39	P51	I	$\overline{\text{A HALF}}$	Deck A Half switch input											

PIN No.	PIN NAME	I/O	SIGNAL NAME	FUNCTION
40	P50	I	AMSIN	AMS signal input
41	P17	O	$\overline{\text{MMUTE}}$	Meter mute output
42	P16	O	$\overline{\text{LMUTE}}$	Line mute output
43	P15	O	$\overline{\text{PASS}}$	PASS AMP change output
44	P14	O	$\overline{\text{REC/PB}}$	Dolby IC REC/PB select output
45	P13	O	$\overline{\text{AMS/BS}}$	AMS AMP characteristics change output
46	P12	O	AMS A/ $\overline{\text{B}}$	AMS AMP input Deck A/B select output
47	P11	O	SEL A/ $\overline{\text{B}}$	Dolby IC PB input Deck A/B select output
48	P10	O	$\overline{\text{BIAS I}}$	TYPE I bias oscillation output
49	P07	O	$\overline{\text{RELAY}}$	REC/PB change relay output
50	P06	O	$\overline{\text{PM B}}$	Deck B plunger hold output
51	P05	O	$\overline{\text{KICK B}}$	Deck B plunger kick output
52	P04	O	$\overline{\text{PM A}}$	Deck A plunger hold output
53	P03	O	$\overline{\text{KICK A}}$	Deck A plunger kick output
54	P02	O	B H/ $\overline{\text{L}}$	Deck B capstan motor speed select
55	P01	O	A H/ $\overline{\text{L}}$	Deck A capstan motor speed select
56	P00	O	M $\overline{\text{ON/OFF}}$	Capstan motor $\overline{\text{ON/OFF}}$
57	P27	O	REC MUTE	REC MUTE output
58	P26	O	B SCHMITT	Deck B reel table schmitt output
59	P25	O	A SCHMITT	Deck A reel table schmitt output
60	P24	O	$\overline{\text{HDUB}}$	High Speed Dubbing LED output
61	P23	O	$\overline{\text{NDUB}}$	Normal Speed Dubbing LED output
62	P22	O	$\overline{\text{CD DUB}}$	Auto CD Synchro LED output
63	P21	O	$\overline{\text{A PAUSE}}$	Deck A PAUSE LED output
64	P20	O	$\overline{\text{SIRCS/AUB}}$	SIRCS/AUDIO BUS mode select

#### [TEST MODE]

When making pin ③ low (connect TP1 to ground with jumper wire), following function operates.

1. Source monitor  
Release the line mute while recording.
2. High speed playback  
On recording, while pressing HIGH SPEED (DUBBING) button, high speed playback operates.
3. Record memory stop  
Using DIRECTION MODE switch  $\rightleftarrows$ , returns to the recording start point and stops or plays.

3-2. BLOCK DIAGRAM

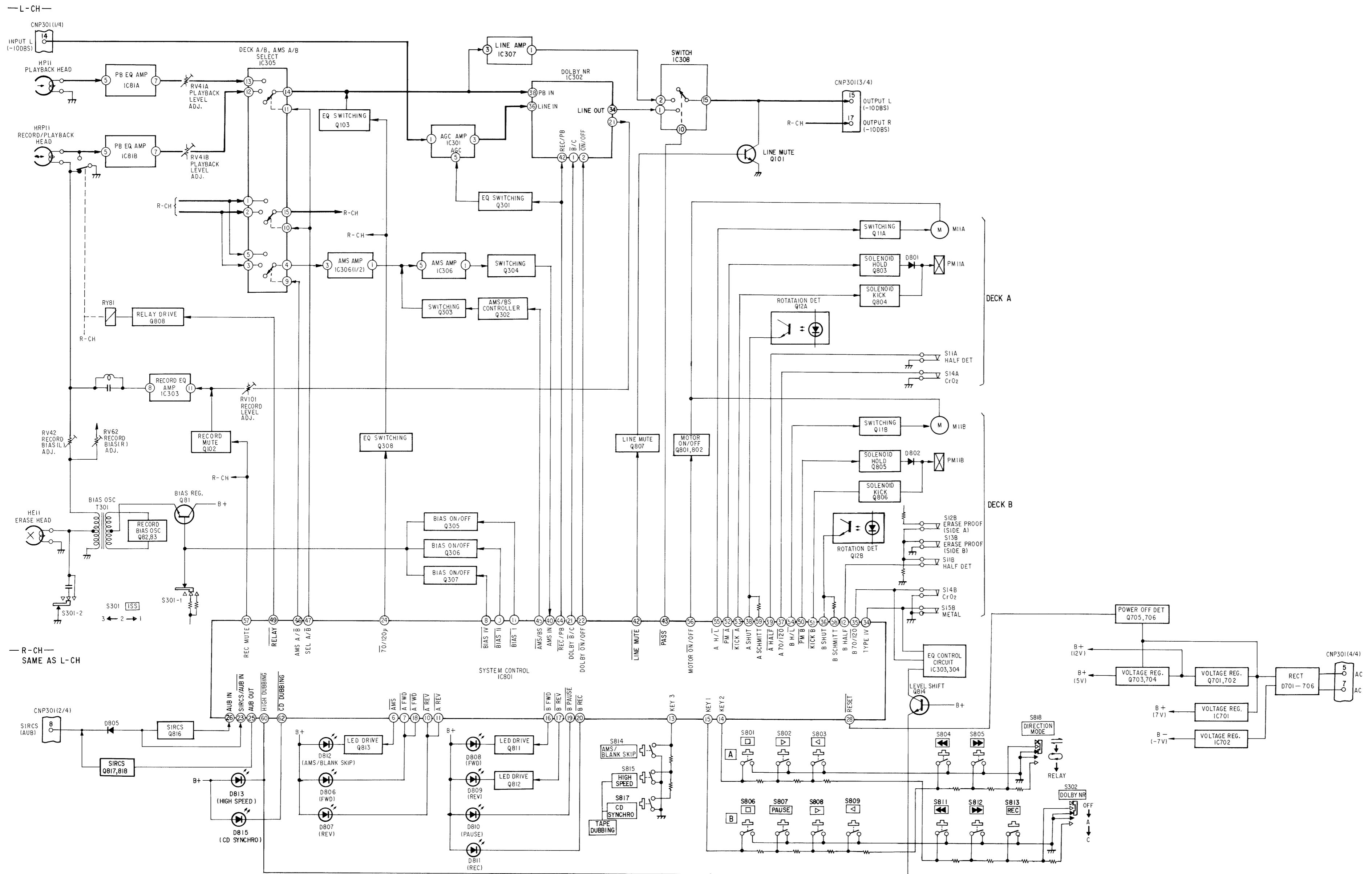



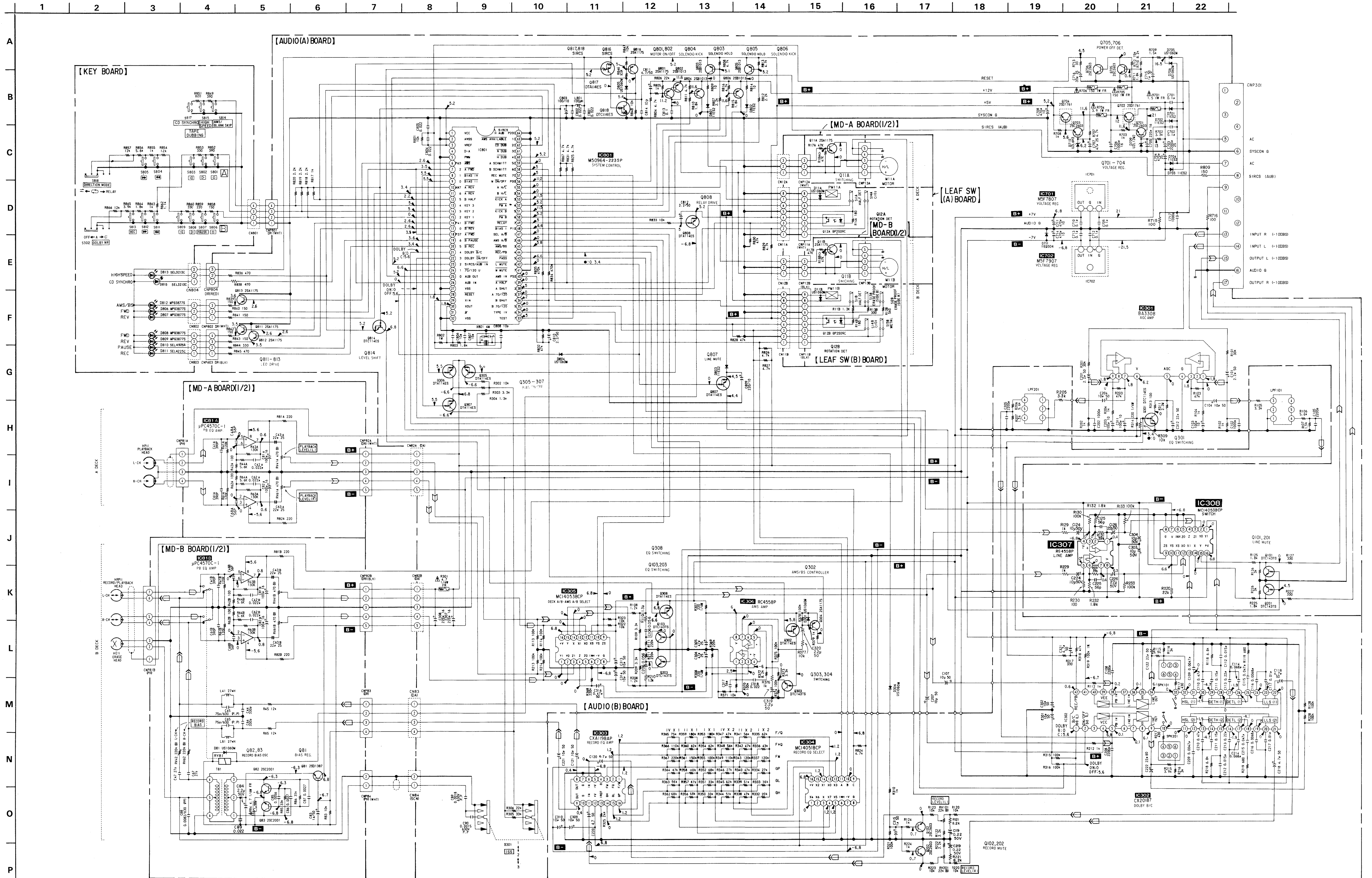

**Note on Schematic Diagram:**

**Note:**

- All capacitors are in  $\mu\text{F}$  unless otherwise noted. pF:  $\mu\text{F}$  50WV or less are not indicated except for electrolytics and tantalums.
- All resistors are in  $\Omega$  and  $\frac{1}{4}\text{W}$  or less unless otherwise specified.
- $\text{FR}$ : fusible resistor.

**Note:**  
The components identified by mark **A** or dotted line with mark **A** are critical for safety.

**Note:**  
Les composants identifiés par une marque **A** sont critiques pour la sécurité. Ne les remplacer que par une pièce portant le numéro spécifié.

- $\square$ : adjustment for repair.
- Voltage and waveforms are dc with respect to ground under no-signal (detuned) conditions. no mark : STOP
- $\bullet$ : REC
- Voltages are taken with a VOM (Input Impedance  $10\text{M}\Omega$ ). Voltage variations may be noted due to normal production tolerances.
- $\curvearrowright$ : PB (DECK A)
- $\curvearrowleft$ : PB (DECK B)
- $\curvearrowright$ : REC (DECK B)

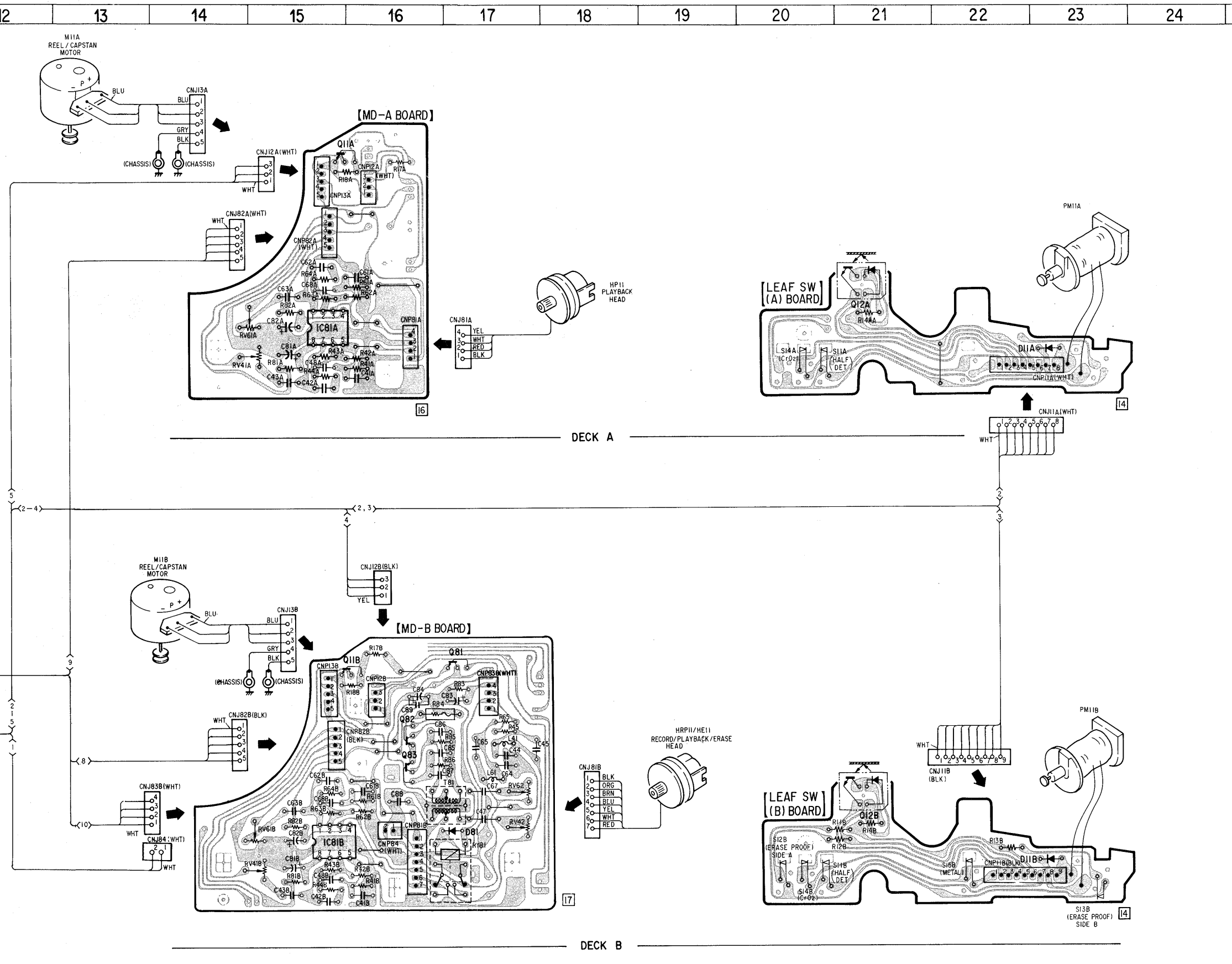
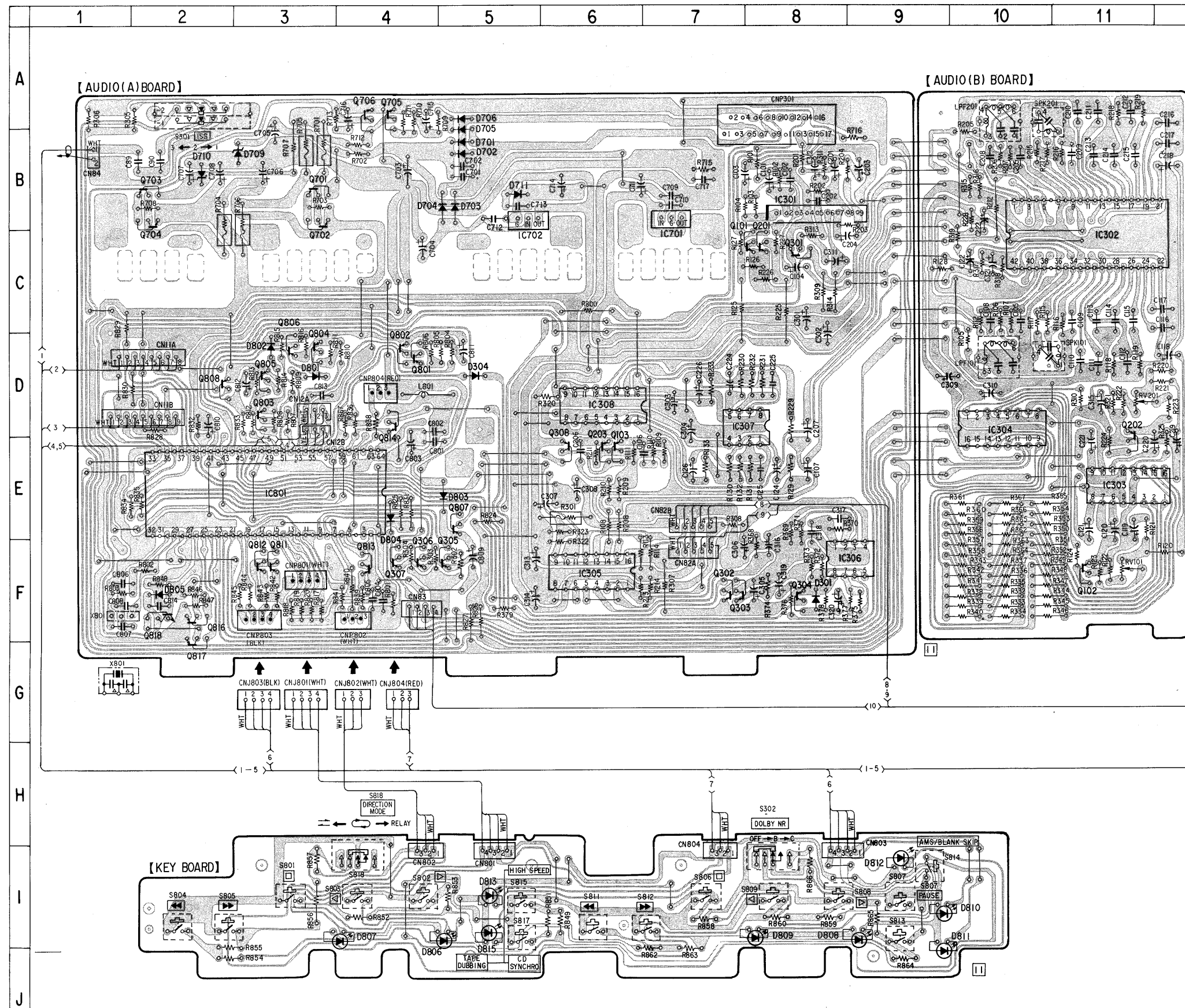

Note:  
 ● ○ : parts extracted from the component side.

● Semiconductor Location

Ref. No.	Location	Ref. No.	Location	Ref. No.	Location
D11A	D-23	IC81A	D-15	Q302	F-7
D11B	I-11	IC81B	I-15	Q303	F-7
D81	I-17	IC301	B-8	Q304	F-8
D301	F-8	IC302	B-11	Q305	F-5
D304	C-5	IC303	E-11	Q306	F-4
D701	B-5	IC304	D-10	Q307	F-4
D702	B-5	IC305	F-6	Q308	E-6
D703	B-5	IC306	F-8	Q701	B-3
D704	B-5	IC307	D-7	Q702	B-3
D705	A-5	IC308	D-6	Q703	B-2
D706	A-5	IC701	B-7	Q704	B-2
D709	B-3	IC702	B-5	Q705	A-4
D710	B-2	IC801	E-3	Q706	A-4
D711	B-5			Q801	D-4
D801	C-3	Q11A	B-16	Q802	D-4
D802	C-3	Q11B	G-16	Q803	D-3
D803	E-5	Q12A	C-21	Q804	D-3
D804	E-4	Q12B	H-21	Q805	D-3
D805	F-2	Q81	G-17	Q806	D-3
D806	I-4	Q82	H-16	Q807	E-5
D807	I-4	Q83	H-16	Q808	D-2
D808	I-9	Q101	C-7	Q811	F-3
D809	I-8	Q102	F-11	Q812	F-3
D810	I-9	Q103	E-6	Q813	F-4
D811	I-9	Q201	C-8	Q814	D-4
D812	I-9	Q202	D-11	Q816	F-2
D813	I-5	Q203	E-6	Q817	F-2
D815	I-5	Q301	C-8	Q818	F-2

● Semiconductor Lead Layouts

BA3308



2SA1175-HFE

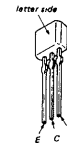

HZ12B2L  
1SS132

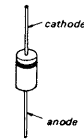

M5F7807

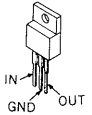

2SB1013-4  
2SC2001  
2SD1388



MPG3877S  
SEL3213C-D



M5F7907

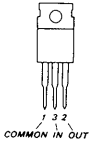

2SD1761-EF



SEL4225C-D  
SEL4925A-D



TC4051BPHB

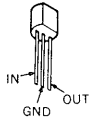

GP-2S09-C

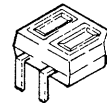

DTA114ES  
DTC114ES  
DTC143TS  
2SC2603-EF



HZS6C3L  
1SS120  
11EQS04  
11ES2

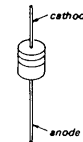



**4-2. MECHANICAL BLOCK (1)**  
**(DECK A : TCM-170RA1)**  
**(DECK B : TCM-170RB7)**

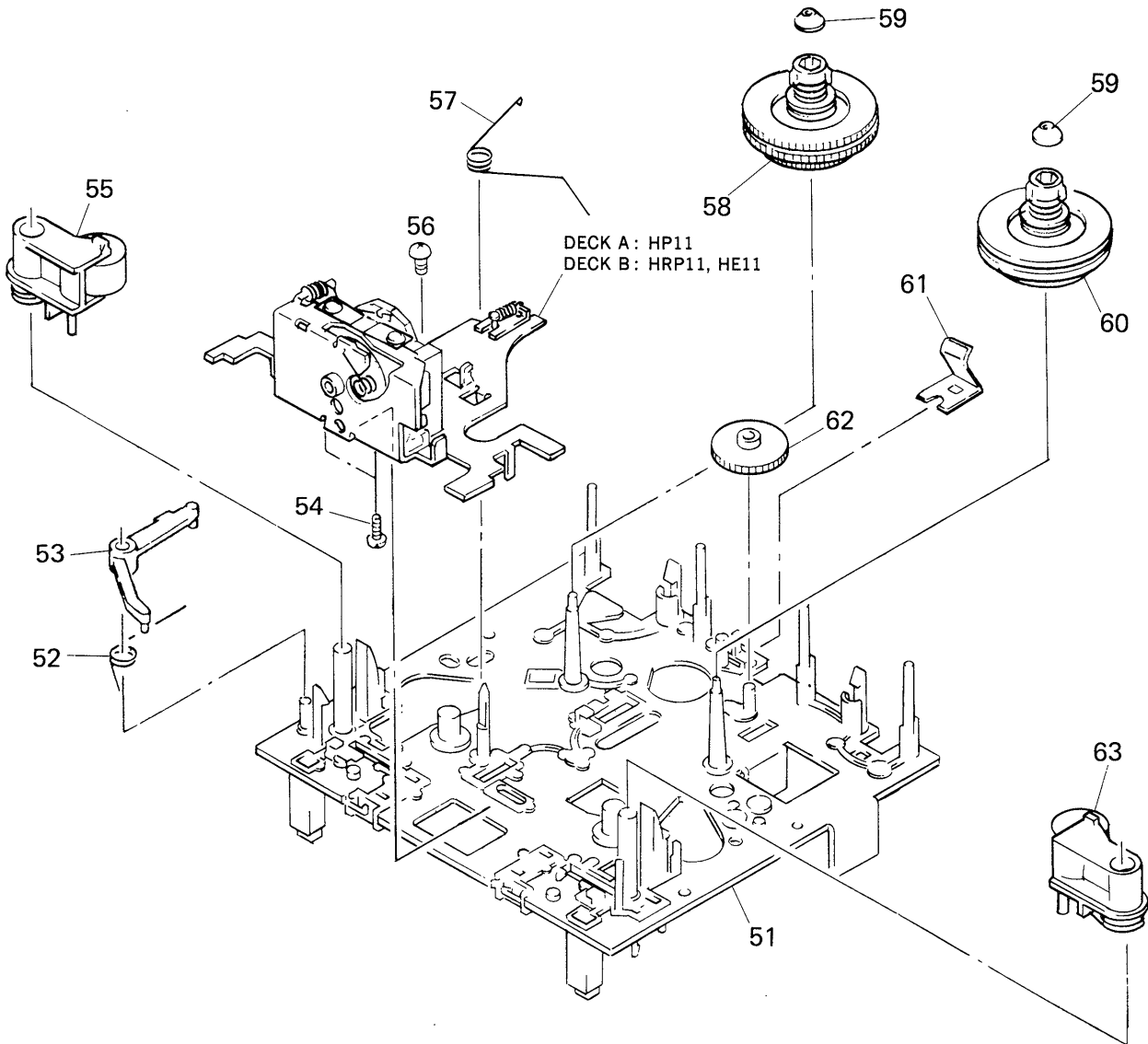

Ref.No	Part No.	Description	Remarks	Ref.No	Part No.	Description	Remarks
51	X-3343-439-1	CHASSIS ASSY, MECHANICAL		59	3-343-439-01	CAP (REEL TABLE)	
52	3-343-477-01	SPRING, TORSION (EJECT SAFTY)		60	X-3343-401-1	TABEL ASSY, REEL	
53	3-343-476-01	LEVER (EJECT SAFETY LEVER)		61	3-343-420-01	SPRING, LEAF	
54	7-685-102-19	SCREW +P 2X4 NON-SLIT TYPE 2		62	3-343-411-01	GEAR (FF GEAR)	
55	X-3343-456-1	LEVER (PINCH R) ASSY		63	X-3343-455-1	LEVER (PINCH F) ASSY	
56	7-621-773-86	SCREW +BVTT 2.6X4 (S)		HP11	A-2003-503-A	(DECK A)...PC BOARD ASSY, HEAD	
57	3-343-401-01	SPRING, TORSION		HRP11	A-2003-504-A	(DECK B)...CHASSIS ASSY, HEAD	
58	X-3343-415-1	TABEL (REV) ASSY, REEL					

**4-3. MECHANICAL BLOCK (2)**  
**(DECK A : TCM-170RA1)**  
**(DECK B : TCM-170RB7)**

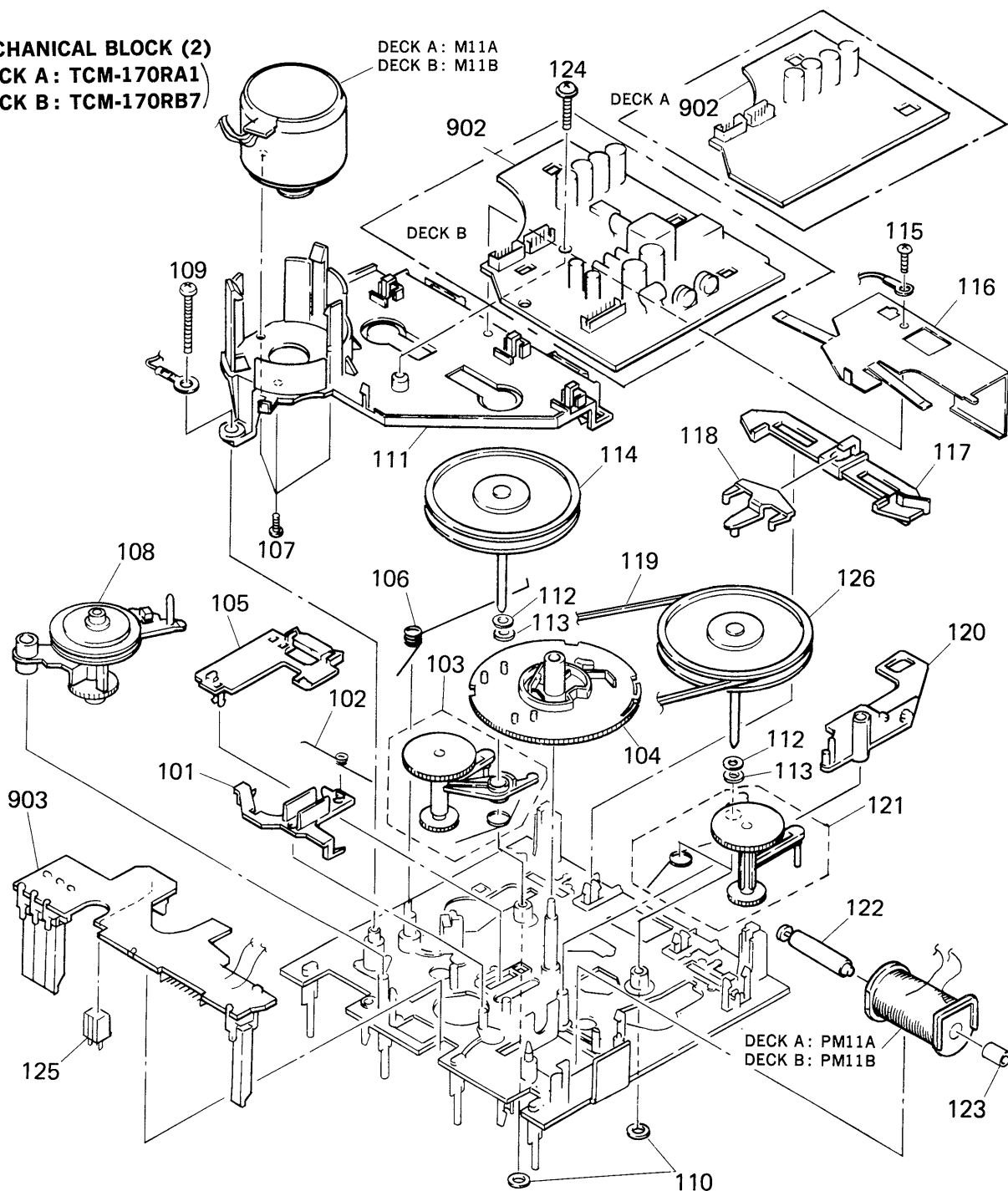

Ref.No	Part No.	Description	Remarks	Ref.No	Part No.	Description	Remarks
101	3-343-453-01	SLIDER (BRAKE PLATE)		118	3-343-462-01	LEVER	
102	3-343-429-01	SPRING, TORSION		119	3-313-816-02	BELT (CAPSTAN BELT SQUARE)	
103	X-3343-454-1	LEVER (TU-R) ASSY		120	3-343-493-01	LEVER (PM LEVER)	
104	3-343-470-01	GEAR (CAM GEAR)		121	X-3343-453-1	LEVER (TU-F) ASSY	
105	3-343-461-01	SLIDER		122	*3-343-425-01	ARBOR(MOVABLE IRON ARBOR),IRON	
106	3-343-430-01	SPRING, TORSION		123	*3-343-424-01	ARBOR (FIXED IRON ARBOR), IRON	
107	7-627-556-28	SCREW +P 2.6X3.5		124	3-343-404-01	SCREW (PTPWH 2X12)	
108	X-3343-414-1	LAVER (FR ARM) ASSY		125	3-343-419-01	HOLDER (S SENSER A)	
109	3-355-801-01	SCREW (BTP 2X18)		126	X-3343-416-7	FLYWHEEL (REV) COMPLETE ASSY	
110	3-343-473-01	WASHER, NYLON		902	*1-624-146-11	(DESK B)...PC BOARD,MD-B	
111	*X-3343-407-1	BASE (THRUST RETAINER) ASSY		902	*1-624-147-11	(DECK A)...PC BOARD, MD-A	
112	4-605-835-11	WASHER (2.6), POLYSLIDER		903	*1-624-148-11	PC BOARD, LEAF SW	
113	3-307-482-00	WASHER, LUMILER		M11A	X-3343-447-1	(DECK A)...MOTOR ASSY	
114	X-3343-411-6	FLYWHEEL COMPLETE ASSY		M11B	X-3343-447-1	(DECK B)...MOTOR ASSY	
115	7-685-104-19	SCREW +P 2X6 TYPE2 NON-SLIT		PM11A	1-454-456-11	(DECK A)...SOLENOID, PLUNGER	
116	3-343-480-01	PLATE, SHIELD		PM11B	1-454-456-11	(DECK B)...SOLENOID, PLUNGER	
117	3-343-457-01	SLIDER (REVERSE SLIDER)					

## SECTION 5 ELECTRICAL PARTS LIST

**NOTE:**

- Due to standardization, replacements in the parts list may be different from the parts specified in the diagrams or the components used on the set.
- Items marked "★" are not stocked since they are seldom required for routine service. Some delay should be anticipated when ordering these items.
- If there are two or more same circuits in a set such as a stereophonic machine, only typical circuit parts may be indicated and capacitors and resistors in other same circuits may be omitted.

**CAPACITORS:**

MF:  $\mu$ F, PF:  $\mu$  $\mu$ F.

**RESISTORS**

- All resistors are in ohms.
- F: nonflammable

**COILS**

- MMH: mH, UH:  $\mu$ H

**SEMICONDUCTORS**

In each case, U:  $\mu$ , for example:  
 UA...:  $\mu$ A..., UPA...:  $\mu$ PA...,  
 UPC...:  $\mu$ PC, UPD...:  $\mu$ PD...

The components identified by mark or dotted line with mark are critical for safety. Replace only with part number specified.

Les composants identifiés par une marque sont critiques pour la sécurité. Ne les remplacer que par une pièce portant le numéro spécifié.

Ref.No	Part No.	Description			
901	* A-2006-231-A	MOUNTED PCB, AUDIO			
902	* 1-624-146-11	(DESK B)...PC BOARD,MD-B			
902	* 1-624-147-11	(DECK A)...PC BOARD, MD-A			
903	* 1-624-148-11	PC BOARD, LEAF SW			
<b>CAPACITOR</b>					
C41A	1-162-289-31	CERAMIC	390PF	10%	50V
C41B	1-162-289-31	CERAMIC	390PF	10%	50V
C42A	1-136-157-00	FILM	0.022MF	5%	50V
C42B	1-136-157-00	FILM	0.022MF	5%	50V
C43A	1-124-282-00	ELECT	22MF	20%	25V
C43B	1-124-282-00	ELECT	22MF	20%	25V
C44	1-162-288-31	CERAMIC	330PF	10%	50V
C45	1-136-273-91	FILM	75PF	5%	630V
C47	1-162-209-31	CERAMIC	27PF	5%	50V
C48A	1-162-217-31	CERAMIC	56PF	5%	50V
C48B	1-162-217-31	CERAMIC	56PF	5%	50V
C61A	1-162-289-31	CERAMIC	390PF	10%	50V
C61B	1-162-289-31	CERAMIC	390PF	10%	50V
C62A	1-136-157-00	FILM	0.022MF	5%	50V
C62B	1-136-157-00	FILM	0.022MF	5%	50V
C63A	1-124-282-00	ELECT	22MF	20%	25V
C63B	1-124-282-00	ELECT	22MF	20%	25V
C64	1-162-288-31	CERAMIC	330PF	10%	50V
C65	1-136-273-91	FILM	75PF	5%	630V
C67	1-162-209-31	CERAMIC	27PF	5%	50V
C68A	1-162-217-31	CERAMIC	56PF	5%	50V
C68B	1-162-217-31	CERAMIC	56PF	5%	50V
C81A	1-126-101-11	ELECT	100MF	20%	16V
C81B	1-126-101-11	ELECT	100MF	20%	16V
C82A	1-126-101-11	ELECT	100MF	20%	16V
C82B	1-126-101-11	ELECT	100MF	20%	16V
C83	1-124-791-11	ELECT	1MF	20%	50V
C84	1-124-925-11	ELECT	2.2MF	20%	50V
C85	1-130-480-00	MYLAR	0.0056MF	5%	50V
C86	1-130-476-00	MYLAR	0.0027MF	5%	50V
C87	1-130-476-00	MYLAR	0.0027MF	5%	50V
C88	1-136-562-11	FILM	0.0082MF	5%	630V
C89	1-136-554-11	FILM	0.0018MF	5%	630V
C89	1-161-494-00	CERAMIC	0.022MF	25V	
C90	1-136-553-11	FILM	0.0015MF	5%	630V
C101	1-124-925-11	ELECT	2.2MF	20%	50V
C102	1-162-294-31	CERAMIC	0.001MF	10%	50V
C103	1-124-443-00	ELECT	100MF	20%	10V
C104	1-123-875-11	ELECT	10MF	20%	50V
C105	1-161-375-00	CERAMIC	0.0022MF	20%	16V
C106	1-136-162-00	FILM	0.056MF	5%	50V
C107	1-123-875-11	ELECT	10MF	20%	50V
C108	1-161-375-00	CERAMIC	0.0022MF	20%	16V
C109	1-130-479-00	MYLAR	0.0047MF	5%	50V
C110	1-136-173-00	FILM	0.47MF	5%	50V
C111	1-136-167-00	FILM	0.15MF	5%	50V
C112	1-136-155-00	FILM	0.015MF	5%	50V
C113	1-136-169-00	FILM	0.22MF	5%	50V
C114	1-136-163-00	FILM	0.068MF	5%	50V

Ref.No	Part No.	Description			
C115	1-136-161-00	FILM	0.047MF	5%	50V
C116	1-130-481-00	MYLAR	0.0068MF	5%	50V
C117	1-136-153-00	FILM	0.01MF	5%	50V
C118	1-124-927-11	ELECT	4.7MF	20%	50V
C119	1-124-464-11	ELECT	0.22MF	20%	50V
C120	1-124-927-11	ELECT	4.7MF	20%	50V
C121	1-123-875-11	ELECT	10MF	20%	50V
C122	1-126-233-11	ELECT	22MF	20%	50V
C124	1-123-875-11	ELECT	10MF	20%	50V
C125	1-162-217-31	CERAMIC	56PF	5%	50V
C126	1-126-233-11	ELECT	22MF	20%	50V
C201	1-124-925-11	ELECT	2.2MF	20%	50V
C202	1-162-294-31	CERAMIC	0.001MF	10%	50V
C203	1-124-443-00	ELECT	100MF	20%	10V
C204	1-123-875-11	ELECT	10MF	20%	50V
C205	1-161-375-00	CERAMIC	0.0022MF	20%	16V
C206	1-136-162-00	FILM	0.056MF	5%	50V
C207	1-123-875-11	ELECT	10MF	20%	50V
C208	1-161-375-00	CERAMIC	0.0022MF	20%	16V
C209	1-130-479-00	MYLAR	0.0047MF	5%	50V
C210	1-136-173-00	FILM	0.47MF	5%	50V
C211	1-136-167-00	FILM	0.15MF	5%	50V
C212	1-136-155-00	FILM	0.015MF	5%	50V
C213	1-136-169-00	FILM	0.22MF	5%	50V
C214	1-136-163-00	FILM	0.068MF	5%	50V
C215	1-136-161-00	FILM	0.047MF	5%	50V
C216	1-130-481-00	MYLAR	0.0068MF	5%	50V
C217	1-136-153-00	FILM	0.01MF	5%	50V
C218	1-124-927-11	ELECT	4.7MF	20%	50V
C219	1-124-464-11	ELECT	0.22MF	20%	50V
C220	1-124-927-11	ELECT	4.7MF	20%	50V
C221	1-123-875-11	ELECT	10MF	20%	50V
C222	1-126-233-11	ELECT	22MF	20%	50V
C224	1-123-875-11	ELECT	10MF	20%	50V
C225	1-162-217-31	CERAMIC	56PF	5%	50V
C226	1-126-233-11	ELECT	22MF	20%	50V
C301	1-123-875-11	ELECT	10MF	20%	50V
C302	1-123-875-11	ELECT	10MF	20%	50V
C303	1-123-875-11	ELECT	10MF	20%	50V
C304	1-123-875-11	ELECT	10MF	20%	50V
C305	1-124-477-11	ELECT	47MF	20%	25V
C306	1-124-477-11	ELECT	47MF	20%	25V
C307	1-124-120-11	ELECT	220MF	20%	16V
C308	1-124-120-11	ELECT	220MF	20%	16V
C309	1-123-875-11	ELECT	10MF	20%	50V
C310	1-123-875-11	ELECT	10MF	20%	50V
C311	1-124-443-00	ELECT	100MF	20%	10V
C312	1-126-233-11	ELECT	22MF	20%	50V
C313	1-123-875-11	ELECT	10MF	20%	50V
C314	1-123-875-11	ELECT	10MF	20%	50V
C315	1-124-791-11	ELECT	1MF	20%	50V
C316	1-124-902-00	ELECT	0.47MF	20%	50V
C317	1-162-217-31	CERAMIC	56PF	5%	50V
C318	1-136-157-00	FILM	0.022MF	5%	50V
C319	1-124-925-11	ELECT	2.2MF	20%	50V

REVISED

Ref.No	Part No.	Description				Ref.No	Part No.	Description
C320	1-124-925-11	ELECT	2.2MF	20%	50V	D711	8-719-210-21	DIODE 11EQS04
C321	1-124-927-11	ELECT	4.7MF	20%	50V	D801	8-719-200-82	DIODE 11ES2
C701	1-164-159-11	CERAMIC	0.1MF		50V	D802	8-719-200-82	DIODE 11ES2
C702	1-164-159-11	CERAMIC	0.1MF		50V	D803	8-719-200-82	DIODE 11ES2
C703	1-124-563-11	ELECT	2200MF	20%	25V	D804	8-719-912-20	DIODE 1SS120
C704	1-124-480-11	ELECT	470MF	20%	25V	D805	8-719-912-20	DIODE 1SS120
C705	1-124-120-11	ELECT	220MF	20%	16V	D806	8-719-942-15	DIODE MPG3877S
C706	1-124-360-00	ELECT	1000MF	20%	16V	D807	8-719-942-15	DIODE MPG3877S
C707	1-124-477-11	ELECT	47MF	20%	25V	D808	8-719-942-15	DIODE MPG3877S
C708	1-124-472-11	ELECT	470MF	20%	10V	D809	8-719-942-15	DIODE MPG3877S
C709	1-164-159-11	CERAMIC	0.1MF		50V	D810	8-719-310-04	DIODE SEL4925A-D
C710	1-164-159-11	CERAMIC	0.1MF		50V	D811	8-719-312-38	DIODE SEL4225C-D
C711	1-124-472-11	ELECT	470MF	20%	10V	D812	8-719-942-15	DIODE MPG3877S
C712	1-164-159-11	CERAMIC	0.1MF		50V	D813	8-719-311-05	DIODE SEL3213C-D
C713	1-164-159-11	CERAMIC	0.1MF		50V	D815	8-719-311-05	DIODE SEL3213C-D
C714	1-124-472-11	ELECT	470MF	20%	10V	HP11	A-2003-503-A (DECK A)...	PC BOARD ASSY, HEAD
C715	1-124-791-11	ELECT	1MF	20%	50V	HRP11	A-2003-504-A (DECK B)...	CHASSIS ASSY, HEAD
C716	1-124-482-11	ELECT	33MF	20%	25V	IC81A	8-759-111-44	IC UPC4570C-1
C717	1-162-294-31	CERAMIC	0.001MF	10%	50V	IC81B	8-759-111-44	IC UPC4570C-1
C801	1-161-494-00	CERAMIC	0.022MF		25V	IC301	8-759-939-73	IC BA3308
C802	1-161-494-00	CERAMIC	0.022MF		25V	IC302	8-752-018-70	IC CX20187
C803	1-124-443-00	ELECT	100MF	20%	10V	IC303	8-752-033-61	IC CXA1198AP
C804	1-161-494-00	CERAMIC	0.022MF		25V	IC304	8-759-208-06	IC TC4051BPHB
C805	1-161-494-00	CERAMIC	0.022MF		25V	IC305	8-759-040-53	IC MC14053BCP
C806	1-162-199-31	CERAMIC	10PF	5%	50V	IC306	8-759-945-58	IC RC4558P
C807	1-162-199-31	CERAMIC	10PF	5%	50V	IC307	8-759-945-58	IC RC4558P
C808	1-162-199-31	CERAMIC	10PF	5%	50V	IC308	8-759-040-53	IC MC14053BCP
C809	1-126-176-11	ELECT	220MF	20%	10V	IC701	8-759-604-86	IC M5F7807
C810	1-124-925-11	ELECT	2.2MF	20%	50V	IC702	8-759-604-90	IC M5F7907
C811	1-124-927-11	ELECT	4.7MF	20%	50V	IC801	8-759-635-01	IC M50964-223SP
C812	1-124-925-11	ELECT	2.2MF	20%	50V	L41	1-410-780-11	INDUCTOR 27MMH
C813	1-164-159-11	CERAMIC	0.1MF		50V	L61	1-410-780-11	INDUCTOR 27MMH
C814	1-162-199-31	CERAMIC	10PF	5%	50V	L801	1-408-080-00	INDUCTOR 100UH
CN84	*1-564-704-11	PIN, CONNECTOR (SMALL TYPE) 2P				LPF101	1-236-087-11	FILTER, LOW PASS
CNP11A	1-564-501-11	PIN, CONNECTOR 8P				LPF201	1-236-087-11	FILTER, LOW PASS
CNP11B	1-506-615-11	PIN, CONNECTOR 9P				M11A	X-3343-447-1 (DECK A)...	MOTOR ASSY
CNP12A	*1-564-337-00	PIN, CONNECTOR 3P				M11B	X-3343-447-1 (DECK B)...	MOTOR ASSY
CNP12B	*1-564-337-61	PIN, CONNECTOR 3P				PM11A	1-454-456-11 (DECK A)...	SOLENOID, PLUNGER
CNP13A	*1-564-707-11	PIN, CONNECTOR (SMALL TYPE) 5P				PM11B	1-454-456-11 (DECK B)...	SOLENOID, PLUNGER
CNP13B	*1-564-707-11	PIN, CONNECTOR (SMALL TYPE) 5P				Q11A	8-729-119-76	TRANSISTOR 2SA1175-HFE
CNP81A	*1-564-706-11	PIN, CONNECTOR (SMALL TYPE) 4P				Q11B	8-729-119-76	TRANSISTOR 2SA1175-HFE
CNP81B	*1-564-709-11	PIN, CONNECTOR (SMALL TYPE) 7P				Q12A	8-719-939-23	PHOTO TRANSISTOR GP2S09-C
CNP82A	*1-564-339-00	PIN, CONNECTOR 5P				Q12B	8-719-939-23	PHOTO TRANSISTOR GP2S09-C
CNP82B	*1-564-339-61	PIN, CONNECTOR 5P				Q81	8-729-111-29	TRANSISTOR 2SD1616A-K
CNP83	*1-564-338-61	PIN, CONNECTOR 4P				Q82	8-729-100-13	TRANSISTOR 2SC2001
CNP84	*1-564-704-11	PIN, CONNECTOR (SMALL TYPE) 2P				Q83	8-729-100-13	TRANSISTOR 2SC2001
CNP301	*1-569-624-11	SOCKET, CONNECTOR 17P				Q101	8-729-900-74	TRANSISTOR DTC143TS
CNP801	*1-564-338-00	PIN, CONNECTOR 4P				Q102	8-729-620-05	TRANSISTOR 2SC2603-EF
CNP802	*1-564-337-00	PIN, CONNECTOR 3P				Q103	8-729-900-74	TRANSISTOR DTC143TS
CNP803	*1-564-338-61	PIN, CONNECTOR 4P				Q201	8-729-900-74	TRANSISTOR DTC143TS
CNP804	*1-564-337-71	PIN, CONNECTOR 3P				Q202	8-729-620-05	TRANSISTOR 2SC2603-EF
D11A	8-719-107-94	DIODE 1SS132				Q203	8-729-900-74	TRANSISTOR DTC143TS
D11B	8-719-107-94	DIODE 1SS132				Q301	8-729-900-80	TRANSISTOR DTC114ES
D81	8-719-107-94	DIODE 1SS132				Q302	8-729-900-61	TRANSISTOR DTA114ES
D301	8-719-912-20	DIODE 1SS120				Q303	8-729-900-74	TRANSISTOR DTC143TS
D304	8-719-912-20	DIODE 1SS120				Q304	8-729-119-76	TRANSISTOR 2SA1175-HFE
D701	8-719-200-82	DIODE 11ES2				Q305	8-729-900-61	TRANSISTOR DTA114ES
D702	8-719-200-82	DIODE 11ES2				Q306	8-729-900-61	TRANSISTOR DTA114ES
D703	8-719-200-82	DIODE 11ES2				Q307	8-729-900-61	TRANSISTOR DTA114ES
D704	8-719-200-82	DIODE 11ES2				Q308	8-729-900-61	TRANSISTOR DTA114ES
D705	8-719-912-20	DIODE 1SS120				Q701	8-729-620-05	TRANSISTOR 2SC2603-EF
D706	8-719-912-20	DIODE 1SS120				Q702	8-729-920-98	TRANSISTOR 2SD1761-EF
D709	8-719-910-25	DIODE HZ12B2L						
D710	8-719-933-41	DIODE HZS6C3L						



Ref.No	Part No.	Description			
Q703	8-729-620-05	TRANSISTOR 2SC2603-EF			
Q704	8-729-920-98	TRANSISTOR 2SD1761-EF			
Q705	8-729-620-05	TRANSISTOR 2SC2603-EF			
Q706	8-729-620-05	TRANSISTOR 2SC2603-EF			
Q801	8-729-119-76	TRANSISTOR 2SA1175-HFE			
Q802	8-729-801-84	TRANSISTOR 2SB1013-4			
Q803	8-729-801-84	TRANSISTOR 2SB1013-4			
Q804	8-729-801-84	TRANSISTOR 2SB1013-4			
Q805	8-729-801-84	TRANSISTOR 2SB1013-4			
Q806	8-729-801-84	TRANSISTOR 2SB1013-4			
Q807	8-729-900-61	TRANSISTOR DTA114ES			
Q808	8-729-900-61	TRANSISTOR DTA114ES			
Q811	8-729-119-76	TRANSISTOR 2SA1175-HFE			
Q812	8-729-119-76	TRANSISTOR 2SA1175-HFE			
Q813	8-729-119-76	TRANSISTOR 2SA1175-HFE			
Q814	8-729-900-80	TRANSISTOR DTC114ES			
Q816	8-729-119-76	TRANSISTOR 2SA1175-HFE			
Q817	8-729-900-61	TRANSISTOR DTA114ES			
Q818	8-729-900-80	TRANSISTOR DTC114ES			
<b>RESISTOR</b>					
R11B	1-247-834-11	CARBON	1.3K	5%	1/4W
R12B	1-249-414-11	CARBON	560	5%	1/4W
R13B	1-247-818-11	CARBON	300	5%	1/4W
R14A	1-249-408-11	CARBON	180	5%	1/4W
R14B	1-249-408-11	CARBON	180	5%	1/4W
R17A	1-249-437-11	CARBON	47K	5%	1/4W
R17B	1-249-437-11	CARBON	47K	5%	1/4W
R18A	1-249-437-11	CARBON	47K	5%	1/4W
R18B	1-249-437-11	CARBON	47K	5%	1/4W
R41A	1-247-881-00	CARBON	120K	5%	1/4W
R41B	1-247-881-00	CARBON	120K	5%	1/4W
R42A	1-249-405-11	CARBON	100	5%	1/4W
R42B	1-249-405-11	CARBON	100	5%	1/4W
R43A	1-247-882-11	CARBON	130K	5%	1/4W
R43B	1-247-882-11	CARBON	130K	5%	1/4W
R44A	1-249-426-11	CARBON	5.6K	5%	1/4W
R44B	1-249-426-11	CARBON	5.6K	5%	1/4W
R45	1-249-430-11	CARBON	12K	5%	1/4W
R61A	1-247-881-00	CARBON	120K	5%	1/4W
R61B	1-247-881-00	CARBON	120K	5%	1/4W
R62A	1-249-405-11	CARBON	100	5%	1/4W
R62B	1-249-405-11	CARBON	100	5%	1/4W
R63A	1-247-882-11	CARBON	130K	5%	1/4W
R63B	1-247-882-11	CARBON	130K	5%	1/4W
R64A	1-249-426-11	CARBON	5.6K	5%	1/4W
R64B	1-249-426-11	CARBON	5.6K	5%	1/4W
R65	1-249-430-11	CARBON	12K	5%	1/4W
R81A	1-249-409-11	CARBON	220	5%	1/4W
R81B	1-249-409-11	CARBON	220	5%	1/4W
R82A	1-249-409-11	CARBON	220	5%	1/4W
R82B	1-249-409-11	CARBON	220	5%	1/4W
R83	1-249-429-11	CARBON	10K	5%	1/4W
R84	.1-212-849-00	FUSIBLE	4.7	5%	1/4W
R85	1-249-435-11	CARBON	33K	5%	1/4W
R86	1-249-435-11	CARBON	33K	5%	1/4W
R101	1-247-866-11	CARBON	30K	5%	1/4W
R102	1-249-417-11	CARBON	1K	5%	1/4W
R103	1-249-437-11	CARBON	47K	5%	1/4W
R104	1-249-417-11	CARBON	1K	5%	1/4W
R105	1-249-423-11	CARBON	3.3K	5%	1/4W
R106	1-249-426-11	CARBON	5.6K	5%	1/4W
R107	1-247-834-11	CARBON	1.3K	5%	1/4W
R108	1-249-418-11	CARBON	1.2K	5%	1/4W
R109	1-249-423-11	CARBON	3.3K	5%	1/4W
R110	1-247-834-11	CARBON	1.3K	5%	1/4W

Ref.No	Part No.	Description			
R111	1-247-887-00	CARBON	220K	5%	1/4W
R112	1-249-417-11	CARBON	1K	5%	1/4W
R113	1-249-441-11	CARBON	100K	5%	1/4W
R114	1-249-441-11	CARBON	100K	5%	1/4W
R115	1-249-424-11	CARBON	3.9K	5%	1/4W
R116	1-247-842-11	CARBON	3K	5%	1/4W
R117	1-247-822-11	CARBON	430	5%	1/4W
R118	1-249-427-11	CARBON	6.8K	5%	1/4W
R119	1-249-415-11	CARBON	680	5%	1/4W
R120	1-249-429-11	CARBON	10K	5%	1/4W
R121	1-249-428-11	CARBON	8.2K	5%	1/4W
R122	1-249-421-11	CARBON	2.2K	5%	1/4W
R123	1-249-429-11	CARBON	10K	5%	1/4W
R124	1-249-417-11	CARBON	1K	5%	1/4W
R125	1-249-420-11	CARBON	1.8K	5%	1/4W
R126	1-247-842-11	CARBON	3K	5%	1/4W
R127	1-249-411-11	CARBON	330	5%	1/4W
R128	1-249-441-11	CARBON	100K	5%	1/4W
R129	1-249-417-11	CARBON	1K	5%	1/4W
R130	1-249-441-11	CARBON	100K	5%	1/4W
R131	1-249-436-11	CARBON	39K	5%	1/4W
R132	1-249-420-11	CARBON	1.8K	5%	1/4W
R133	1-249-441-11	CARBON	100K	5%	1/4W
R201	1-247-866-11	CARBON	30K	5%	1/4W
R202	1-249-417-11	CARBON	1K	5%	1/4W
R203	1-249-437-11	CARBON	47K	5%	1/4W
R204	1-249-417-11	CARBON	1K	5%	1/4W
R205	1-249-423-11	CARBON	3.3K	5%	1/4W
R206	1-249-426-11	CARBON	5.6K	5%	1/4W
R207	1-247-834-11	CARBON	1.3K	5%	1/4W
R208	1-249-418-11	CARBON	1.2K	5%	1/4W
R209	1-249-423-11	CARBON	3.3K	5%	1/4W
R210	1-247-834-11	CARBON	1.3K	5%	1/4W
R211	1-247-887-00	CARBON	220K	5%	1/4W
R212	1-249-417-11	CARBON	1K	5%	1/4W
R213	1-249-441-11	CARBON	100K	5%	1/4W
R214	1-249-441-11	CARBON	100K	5%	1/4W
R215	1-249-424-11	CARBON	3.9K	5%	1/4W
R216	1-247-842-11	CARBON	3K	5%	1/4W
R217	1-247-822-11	CARBON	430	5%	1/4W
R218	1-249-427-11	CARBON	6.8K	5%	1/4W
R219	1-249-415-11	CARBON	680	5%	1/4W
R220	1-249-429-11	CARBON	10K	5%	1/4W
R221	1-249-428-11	CARBON	8.2K	5%	1/4W
R222	1-249-421-11	CARBON	2.2K	5%	1/4W
R223	1-249-429-11	CARBON	10K	5%	1/4W
R224	1-249-417-11	CARBON	1K	5%	1/4W
R225	1-249-420-11	CARBON	1.8K	5%	1/4W
R226	1-247-842-11	CARBON	3K	5%	1/4W
R227	1-249-411-11	CARBON	330	5%	1/4W
R228	1-249-441-11	CARBON	100K	5%	1/4W
R229	1-249-417-11	CARBON	1K	5%	1/4W
R230	1-249-441-11	CARBON	100K	5%	1/4W
R231	1-249-436-11	CARBON	39K	5%	1/4W
R232	1-249-420-11	CARBON	1.8K	5%	1/4W
R233	1-249-441-11	CARBON	100K	5%	1/4W
R301	.1-212-849-00	FUSIBLE	4.7	5%	1/4W
R302	1-249-429-11	CARBON	10K	5%	1/4W
R303	1-249-423-11	CARBON	3.3K	5%	1/4W
R304	1-247-834-11	CARBON	1.3K	5%	1/4W
R305	1-249-435-11	CARBON	33K	5%	1/4W
R306	1-249-433-11	CARBON	22K	5%	1/4W
R307	1-249-409-11	CARBON	220	5%	1/4W
R308	1-249-409-11	CARBON	220	5%	1/4W
R309	1-249-429-11	CARBON	10K	5%	1/4W

**Note:**  
The components identified by mark  $\Delta$  or dotted line with mark  $\Delta$  are critical for safety. Replace only with part number specified.

**Note:**  
Les composants identifiés par une marque  $\Delta$  sont critiques pour la sécurité. Ne les remplacer que par une pièce portant le numéro spécifié.

Ref.No	Part No.	Description				
R310	1-249-417-11	CARBON	1K	5%	1/4W	
R311	1-259-880-11	CARBON	2.2M	5%	1/4W	
R313	1-249-405-11	CARBON	100	5%	1/4W	
R314	1-249-409-11	CARBON	220	5%	1/4W	
R315	1-249-441-11	CARBON	100K	5%	1/4W	
R316	1-249-441-11	CARBON	100K	5%	1/4W	
R317	1-249-411-11	CARBON	330	5%	1/4W	
R318	1-249-437-11	CARBON	47K	5%	1/4W	
R319	1-215-469-00	METAL	100K	1%	1/6W	
R320	1-249-433-11	CARBON	22K	5%	1/4W	
R321	1-249-441-11	CARBON	100K	5%	1/4W	
R322	1-249-429-11	CARBON	10K	5%	1/4W	
R323	1-249-429-11	CARBON	10K	5%	1/4W	
R325	1-247-864-11	CARBON	24K	5%	1/4W	
R332	1-247-862-11	CARBON	20K	5%	1/4W	
R333	1-247-868-11	CARBON	36K	5%	1/4W	
R334	1-249-434-11	CARBON	27K	5%	1/4W	
R335	1-247-874-11	CARBON	62K	5%	1/4W	
R336	1-247-870-11	CARBON	43K	5%	1/4W	
R337	1-247-881-00	CARBON	120K	5%	1/4W	
R338	1-249-437-11	CARBON	47K	5%	1/4W	
R339	1-247-872-11	CARBON	51K	5%	1/4W	
R340	1-249-437-11	CARBON	47K	5%	1/4W	
R341	1-249-438-11	CARBON	56K	5%	1/4W	
R342	1-249-437-11	CARBON	47K	5%	1/4W	
R343	1-247-881-00	CARBON	120K	5%	1/4W	
R344	1-247-872-11	CARBON	51K	5%	1/4W	
R345	1-247-874-11	CARBON	62K	5%	1/4W	
R346	1-249-434-11	CARBON	27K	5%	1/4W	
R347	1-249-437-11	CARBON	47K	5%	1/4W	
R348	1-249-438-11	CARBON	56K	5%	1/4W	
R349	1-247-880-11	CARBON	110K	5%	1/4W	
R350	1-249-435-11	CARBON	33K	5%	1/4W	
R351	1-249-435-11	CARBON	33K	5%	1/4W	
R352	1-249-439-11	CARBON	68K	5%	1/4W	
R353	1-247-885-00	CARBON	180K	5%	1/4W	
R354	1-247-874-11	CARBON	62K	5%	1/4W	
R355	1-249-441-11	CARBON	100K	5%	1/4W	
R356	1-249-439-11	CARBON	68K	5%	1/4W	
R357	1-249-437-11	CARBON	47K	5%	1/4W	
R358	1-247-880-11	CARBON	110K	5%	1/4W	
R359	1-247-885-00	CARBON	180K	5%	1/4W	
R360	1-247-874-11	CARBON	62K	5%	1/4W	
R361	1-247-883-00	CARBON	150K	5%	1/4W	
R362	1-249-439-11	CARBON	68K	5%	1/4W	
R363	1-249-438-11	CARBON	56K	5%	1/4W	
R364	1-249-437-11	CARBON	47K	5%	1/4W	
R365	1-247-876-11	CARBON	75K	5%	1/4W	
R366	1-247-880-11	CARBON	110K	5%	1/4W	
R367	1-247-887-00	CARBON	220K	5%	1/4W	
R368	1-247-887-00	CARBON	220K	5%	1/4W	
R369	1-247-887-00	CARBON	220K	5%	1/4W	
R370	1-249-441-11	CARBON	100K	5%	1/4W	
R371	1-249-429-11	CARBON	10K	5%	1/4W	
R372	1-249-428-11	CARBON	8.2K	5%	1/4W	
R373	1-249-423-11	CARBON	3.3K	5%	1/4W	
R374	1-249-441-11	CARBON	100K	5%	1/4W	
R375	1-249-441-11	CARBON	100K	5%	1/4W	
R376	1-249-417-11	CARBON	1K	5%	1/4W	
R377	1-249-429-11	CARBON	10K	5%	1/4W	
R378	1-249-441-11	CARBON	100K	5%	1/4W	
R379	1-249-417-11	CARBON	1K	5%	1/4W	
R701	△.1-219-108-11	FUSIBLE	1.5	5%	1W	F
R702	1-249-423-11	CARBON	3.3K	5%	1/4W	
R703	1-249-417-11	CARBON	1K	5%	1/4W	

Ref.No	Part No.	Description				
R704	△.1-219-109-11	FUSIBLE	3.9	5%	1W	F
R705	△.1-219-110-11	FUSIBLE	150	5%	1W	F
R706	△.1-219-110-11	FUSIBLE	150	5%	1W	F
R707	1-249-425-11	CARBON	4.7K	5%	1/4W	
R708	1-249-417-11	CARBON	1K	5%	1/4W	
R709	1-249-419-11	CARBON	1.5K	5%	1/4W	
R710	1-249-428-11	CARBON	8.2K	5%	1/4W	
R711	1-249-420-11	CARBON	1.8K	5%	1/4W	
R712	1-249-431-11	CARBON	15K	5%	1/4W	
R713	1-249-399-11	CARBON	33	5%	1/4W	
R715	1-249-405-11	CARBON	100	5%	1/4W	
R716	1-249-405-11	CARBON	100	5%	1/4W	
R800	1-249-407-11	CARBON	150	5%	1/4W	
R801	1-249-429-11	CARBON	10K	5%	1/4W	
R802	1-247-903-00	CARBON	1M	5%	1/4W	
R803	1-249-420-11	CARBON	1.8K	5%	1/4W	
R804	1-249-425-11	CARBON	4.7K	5%	1/4W	
R805	1-249-417-11	CARBON	1K	5%	1/4W	
R806	1-249-433-11	CARBON	22K	5%	1/4W	
R807	1-249-421-11	CARBON	2.2K	5%	1/4W	
R808	1-249-425-11	CARBON	4.7K	5%	1/4W	
R809	1-249-393-11	CARBON	10	5%	1/4W	
R810	1-249-420-11	CARBON	1.8K	5%	1/4W	
R811	1-249-425-11	CARBON	4.7K	5%	1/4W	
R812	1-249-421-11	CARBON	2.2K	5%	1/4W	
R813	1-249-425-11	CARBON	4.7K	5%	1/4W	
R814	1-249-393-11	CARBON	10	5%	1/4W	
R815	1-249-420-11	CARBON	1.8K	5%	1/4W	
R816	1-249-425-11	CARBON	4.7K	5%	1/4W	
R817	1-249-417-11	CARBON	1K	5%	1/4W	
R818	1-249-421-11	CARBON	2.2K	5%	1/4W	
R819	1-249-421-11	CARBON	2.2K	5%	1/4W	
R820	1-249-421-11	CARBON	2.2K	5%	1/4W	
R824	1-249-425-11	CARBON	4.7K	5%	1/4W	
R825	1-249-425-11	CARBON	4.7K	5%	1/4W	
R826	1-249-425-11	CARBON	4.7K	5%	1/4W	
R827	1-249-425-11	CARBON	4.7K	5%	1/4W	
R828	1-249-437-11	CARBON	47K	5%	1/4W	
R829	1-249-425-11	CARBON	4.7K	5%	1/4W	
R830	1-249-437-11	CARBON	47K	5%	1/4W	
R831	1-249-425-11	CARBON	4.7K	5%	1/4W	
R832	1-249-437-11	CARBON	47K	5%	1/4W	
R833	1-249-429-11	CARBON	10K	5%	1/4W	
R834	1-247-895-00	CARBON	470K	5%	1/4W	
R835	1-247-895-00	CARBON	470K	5%	1/4W	
R836	1-249-413-11	CARBON	470	5%	1/4W	
R838	1-249-413-11	CARBON	470	5%	1/4W	
R839	1-249-407-11	CARBON	150	5%	1/4W	
R840	1-249-407-11	CARBON	150	5%	1/4W	
R841	1-249-407-11	CARBON	150	5%	1/4W	
R842	1-249-407-11	CARBON	150	5%	1/4W	
R843	1-249-407-11	CARBON	150	5%	1/4W	
R844	1-249-411-11	CARBON	330	5%	1/4W	
R845	1-249-413-11	CARBON	470	5%	1/4W	
R846	1-249-429-11	CARBON	10K	5%	1/4W	
R847	1-249-429-11	CARBON	10K	5%	1/4W	
R848	1-249-429-11	CARBON	10K	5%	1/4W	
R849	1-249-412-11	CARBON	390	5%	1/4W	
R851	1-249-416-11	CARBON	820	5%	1/4W	
R852	1-249-412-11	CARBON	390	5%	1/4W	
R853	1-249-411-11	CARBON	330	5%	1/4W	
R854	1-249-418-11	CARBON	1.2K	5%	1/4W	
R855	1-249-417-11	CARBON	1K	5%	1/4W	
R856	1-249-426-11	CARBON	5.6K	5%	1/4W	
R857	1-249-430-11	CARBON	12K	5%	1/4W	

<p><b>Note:</b> The components identified by mark △ or dotted line with mark △ are critical for safety. Replace only with part number specified.</p>	<p><b>Note:</b> Les composants identifiés par une marque △ sont critiques pour la sécurité. Ne les remplacer que par une pièce portant le numéro spécifié.</p>
--	--

Ref.No	Part No.	Description
R858	1-249-407-11	CARBON 150 5% 1/4W
R859	1-249-409-11	CARBON 220 5% 1/4W
R860	1-249-411-11	CARBON 330 5% 1/4W
R862	1-247-832-11	CARBON 1.1K 5% 1/4W
R863	1-249-417-11	CARBON 1K 5% 1/4W
R864	1-249-420-11	CARBON 1.8K 5% 1/4W
R865	1-249-424-11	CARBON 3.9K 5% 1/4W
R866	1-249-430-11	CARBON 12K 5% 1/4W
R867	1-249-425-11	CARBON 4.7K 5% 1/4W
RV41A	1-228-989-00	RES, ADJ, CARBON 470
RV41B	1-228-989-00	RES, ADJ, CARBON 470
RV42	1-230-500-11	RES, ADJ, CARBON 220K
RV61A	1-228-989-00	RES, ADJ, CARBON 470
RV61B	1-228-989-00	RES, ADJ, CARBON 470
RV62	1-230-500-11	RES, ADJ, CARBON 220K
RV101	1-228-995-00	RES, ADJ, CARBON 22K
RV201	1-228-995-00	RES, ADJ, CARBON 22K
RY81	1-515-614-11	RELAY
S11A	1-571-281-21	SWITCH, LEAF (HALF DET)
S11B	1-571-281-21	SWITCH, LEAF (HALF DET)
S12B	1-571-281-21	SWITCH, LEAF (ERASE PROOF (A))
S13B	1-571-281-21	SWITCH, LEAF (ERASE PROOF (B))
S14A	1-571-281-21	SWITCH, LEAF (CrO <sub>2</sub> )
S14B	1-571-281-21	SWITCH, LEAF (CrO <sub>2</sub> )
S15B	1-571-281-21	SWITCH, LEAF (METAL)
S301	1-554-798-31	SWITCH, SLIDE (ISS)
S302	1-570-835-11	SWITCH, SLIDE (DOLBY NR)
S801	1-572-184-11	SWITCH, KEYBOARD (DECK A : □)
S802	1-572-184-11	SWITCH, KEYBOARD (DECK A : ▷)
S803	1-572-184-11	SWITCH, KEYBOARD (DECK A : ◁)
S804	1-572-184-11	SWITCH, KEYBOARD (DECK A : ◀◀)
S805	1-572-184-11	SWITCH, KEYBOARD (DECK A : ▶▶)
S806	1-572-184-11	SWITCH, KEYBOARD (DECK B : □)
S807	1-572-184-11	SWITCH, KEYBOARD (PAUSE)
S808	1-572-184-11	SWITCH, KEYBOARD (DECK B : ▷)
S809	1-572-184-11	SWITCH, KEYBOARD (DECK B : ◁)
S811	1-572-184-11	SWITCH, KEYBOARD (DECK B : ◀◀)
S812	1-572-184-11	SWITCH, KEYBOARD (DECK B : ▶▶)
S813	1-572-184-11	SWITCH, KEYBOARD (REC)
S814	1-572-184-11	SWITCH, KEYBOARD (ASM/BLANK SKIP)
S815	1-572-184-11	SWITCH, KEYBOARD (HIGH SPEED)
S817	1-572-184-11	SWITCH, KEYBOARD (CD SYNCHRO)
S818	1-570-835-11	SWITCH, SLIDE (DIRECTION MODE)
SPK101	1-235-186-00	ENCAPSULATED COMPONENT
SPK201	1-235-186-00	ENCAPSULATED COMPONENT
T81	1-433-337-11	TRANSFORMER, BIAS OSCILLATION
X801	1-577-358-21	VIBRATOR, CERAMIC (4MHZ)